

Article number: 4395000901

Description: Rota-fix shaft-hub connection F90x130
Stainless steel

Measures

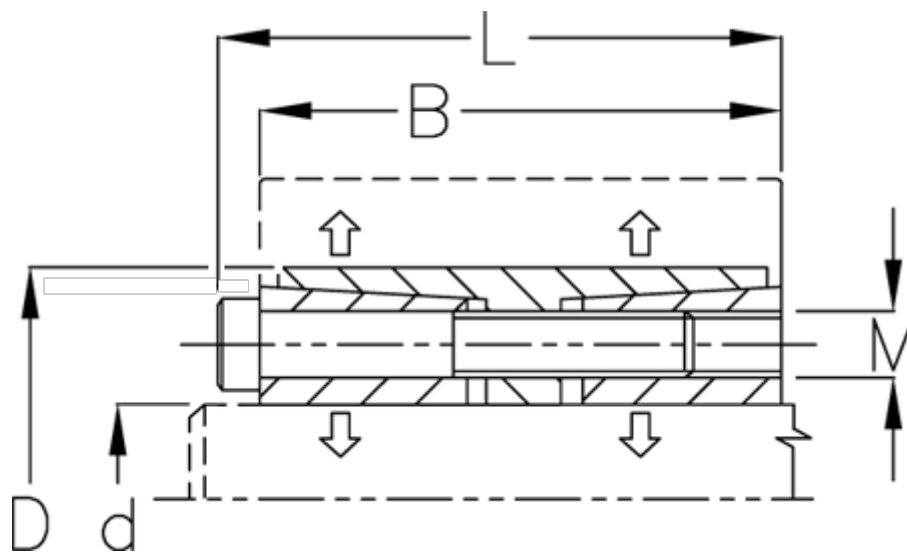

B mm	= 80
d H8 mm	= 90
D mm	= 130
Fit tolerance	= Aksel h8, Nav H8
F kN torque	= 215.0
L mm	= 90
M mm	= M10
P N/mm ² surface pressure on shaft/hub	= 38

Surface roughness	= R ? ? 3.2 μ m
T N m torque	= 9600
Ts N m bolt tightening torque	= 58.0